

hohem

iSteady V3

User Manual V1.0



 Tutorial Video

# Contents

<b>01 Product List</b>	01
<b>02 Overview</b>	02
<b>03 Charging</b>	03
<b>04 Unfolding &amp; Folding</b>	04
Unfolding & Mounting	04
Folding	05
<b>05 Bluetooth Connection</b>	05
<b>06 Usage Modes</b>	05
<b>07 AI Tracking</b>	06
Gesture Control	06
Customized Composition	07
Front/Rear Tracking	07
<b>08 Buttons &amp; Working Mode</b>	08
Buttons	08
Working Mode	09
<b>09 Remote Control Operation</b>	10
<b>10 Indicators</b>	11
<b>11 Hohem Joy App</b>	13
Downloading	13
Gimbal Connection	13
Camera View	13
<b>12 Auto Calibration &amp; Firmware Update</b>	14
<b>13 Specifications</b>	15
<b>14 Warning &amp; Disclaimer</b>	16
<b>15 Warranty Terms</b>	17

# 01 Product List



iSteady V3



Magnetic AI Tracker  
with Fill Light



Remote Controller



USB-C Charging Cable



Hex Key



Storage Pouch



Quick Start Guide



Warranty Card

## 02 Overview

### Front





If the pan motor's base is loose, use the included hex key to tighten the hex screw clockwise.

## 03 Charging

Please fully charge iSteady V3 before using it for the first time.

### Charging Method:

Please use the standard USB-Type C charging cable to connect to the Type-C charging port on the gimbal handle for charging.

\*It is recommended to use a 5V-2A USB charger (not included).

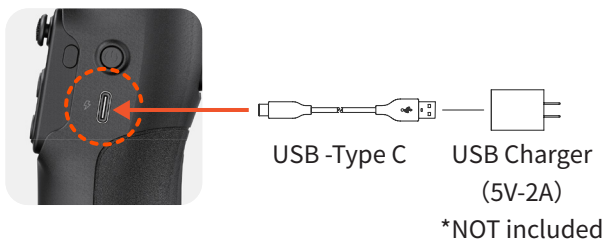

### Charging Display:

- ① Battery indicator light flashing slowly indicates charging (different colors correspond to the current battery level).
- ② Battery indicator light staying solid green indicates charging is complete.

## 04 Unfolding & Folding

Compatible Smartphones  
(≤ 7 inches)

Weight ≤ 300g  
Width: 58-98mm  
Thickness ≤ 12.5 mm

\*Not compatible with Xiaomi 11 Ultra/12S Ultra/13 Ultra/14 Ultra.

### Unfolding & Mounting

① Pull the arm as shown.



② Stretch the phone clamp to adapt to your smartphone's width and attach it to the center of the phone.

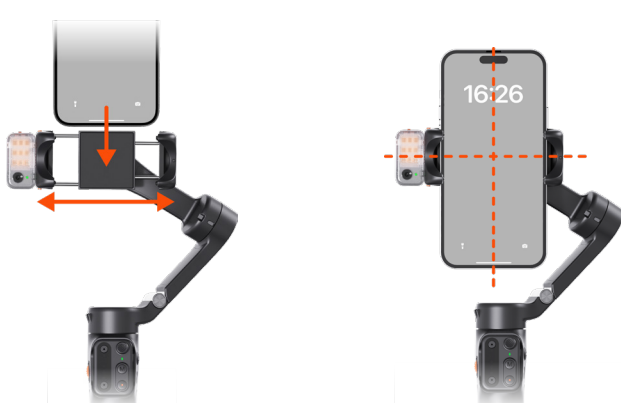

③ Press and hold -  
Power on/off



To set the default orientation for your smartphone upon startup with the iSteady V3:

\*Ensure that the gimbal's Bluetooth is connected to your smartphone.

For a detail explanation, please check **Bluetooth Connection**.



[Tutorial Video](#)

① Open the Hohem Joy App on your smartphone. Tap "Settings".

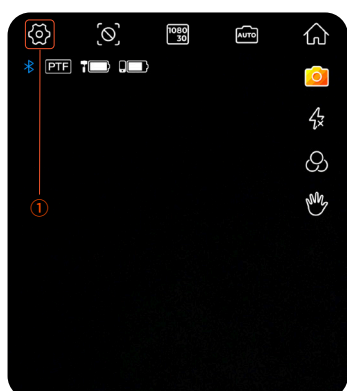

② Tap to "Gimbal Parameter Settings".

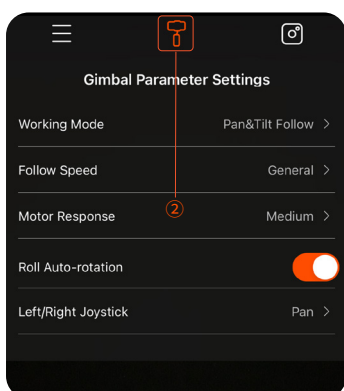

③ Select "Startup Shooting Orientation".

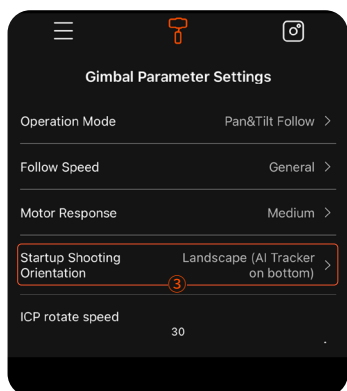

④ Once selected, the gimbal will synchronize to the chosen state. The next time the gimbal is powered on, it will default to this selected orientation.

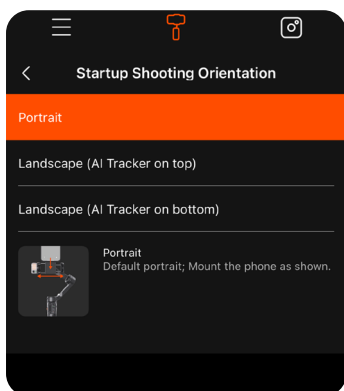

Portrait



Landscape  
(AI Tracker on bottom)



Landscape  
(AI Tracker on top)



- Do not power on the gimbal without mounting a phone.
- If the phone is not centered during startup, it will reduce the gimbal's battery life. The gimbal will automatically enter standby mode if it detects no load or severe imbalance.
- When using the gimbal, avoid touching the pogo pins with your fingers to prevent poor contact.

## Folding

 Ensure the gimbal is powered off before folding it.

Remove the phone. Hold the handle and fold the arm downward and snap the folding lock and the mounting hole together as shown.

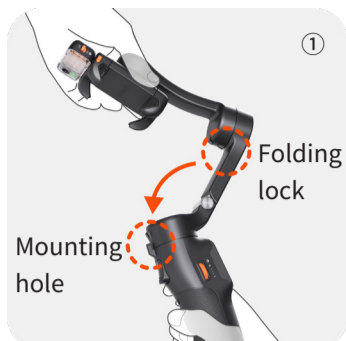

## 05 Bluetooth Connection



OTHER DEVICES ✨

SV3-XXXXXX

To pair an Apple Watch with your iPhone, go to the Apple Watch app.

- ① Make sure the gimbal is powered on.
- ② Activate Bluetooth on your smartphone and select the device named "SV3-XXXXXX" from the list of available devices.
- ③ Follow the on-screen instructions to connect and pair.
- ④ A steady light on the Bluetooth indicator signifies a successful connection.

## 06 Usage Modes

There are 3 usage modes of iSteady V3: **Handheld Mode**, **Extended Mode**, and **Remote Mode**.

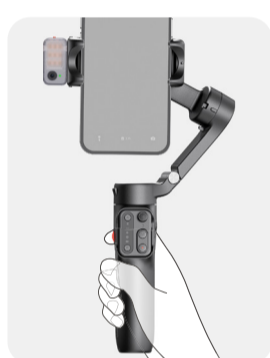

### Handheld Mode

Simply unfold the gimbal for on-the-go shooting.

### Extended Mode

Pull out the built-in extension rod upwards and slightly tilt the hinge area to the preferred angle for shooting.

\*The extension rod includes three segments with a maximum length of 205mm. Adjust the angle from 0° to 90°.



### Remote Mode

Fully pull out the legs and unfold. Stand the gimbal on a desktop surface and remove the remote controller for long-distance remote shooting.

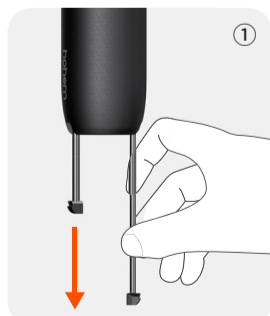

\*Ensure that Bluetooth is connected.



- For increased stability in a wider range of scenarios and conditions, you can also connect iSteady V3 to an external tripod via the 1/4"-20 Screw Hole.
- To retract the tripod, carefully push the legs in.

# 07 AI Tracking

## Mount the AI Tracker



Attach the magnetic AI tracker, aligning the magnetic mount.

## Turn on the AI Tracker



Toggle the switch to "ON". The fill light will flash twice quickly to indicate successful activation.

\*Toggle the switch to "OFF" to turn off the AI Tracker.

## Gesture Control

Show gestures to the AI Tracker from 0.5-1.5m/1.64-4.92ft away.



 Tutorial Video

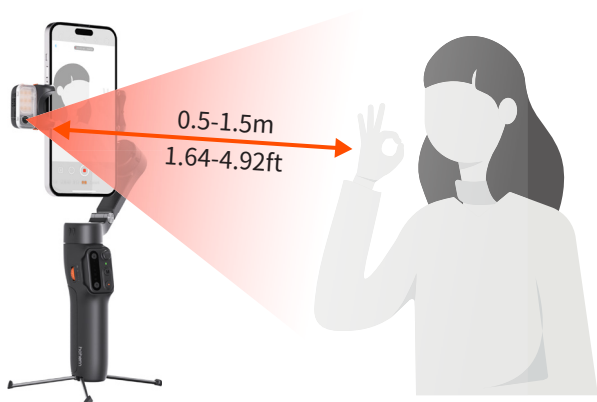

Start AI tracking  
(Indicator light turns green)



Stop AI tracking  
(Indicator light turns red)



Customized  
Composition  
(Indicator light  
flashes green  
quickly)

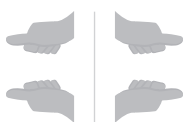

Landscape



Portrait







Shutter Control:  
Photo/Video  
\*Bluetooth  
connection needed.



## Customized Composition

### How to make AI vision positioning adjustments?

If the framed subject cannot be centered on the phone/camera screen, or you want to customize the AI vision position to be tracked:

- ① Make sure the gimbal & AI vision sensor are on.
- ② Take the gesture   towards the AI vision sensor and the indicator blinks green quickly.
- ③ Move in front of the screen until you find the preferred position to be tracked.
- ④ Show the gesture   to lock the position and create ideal composition (the indicator stops flashing).

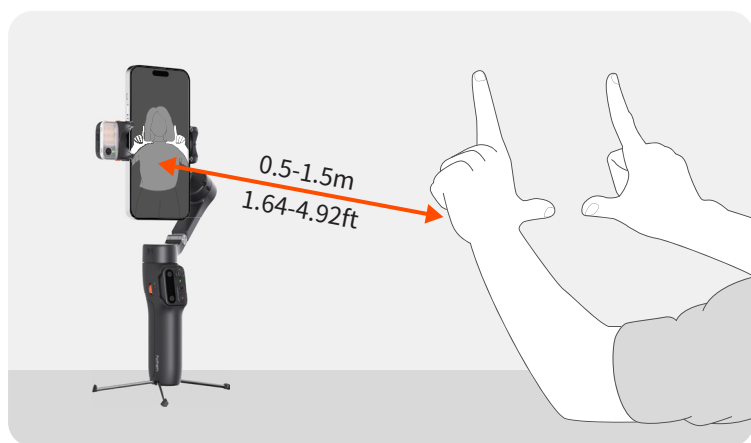
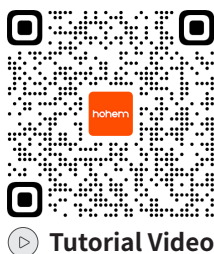

## Front/Rear Tracking

Press and hold the safety locks on both sides of the phone clamp at the same time to unlock it. Remove the AI tracker, rotate it 180°, and then mount the AI tracker.



① Attempting to remove the AI tracker without unlocking it first may result in structural damage to the product.

② When using the AI tracker, it is normal for the pogo-pin at the bottom to become hot. Please avoid direct contact to prevent burns!



# 08 Buttons & Working Mode

## Buttons

---



### Power Button

**Long press:** Power on/off

**Press twice:** Enter standby mode(to exit, press twice again)

**Press five times:** Enter auto calibration

---



### Side Wheel

**Long press:** Turn the fill light on or off (requires AI tracker to be attached)

**Press twice:** Switch between cool, warm, and neutral light

**Scroll up:** Increase the brightness

**Scroll down:** Decrease the brightness

**Press five times:** Re-pair the remote control

**Press seven times:** Clear Bluetooth connections/ Remote connections

---



### Trigger

**Press twice:** Recenter the gimbal

**Press three times:** Change the phone between forward-facing and backward-facing

**Long press:** Enter All Lock Mode(L) (release the trigger to exit)

---



### Type-C Charging Port

Connect the power supply and charge the gimbal.

---



### 1/4"-20 Screw Hole

Connect to other accessories, such as a tripod.

## Working Mode

iSteady V3 three-axis gimbal includes three axes of rotation: pan, tilt, and roll axes. The collaborative work between different axes results in the creation of 4 Working Modes, each tailored to specific filming needs:



Tutorial Video

Roll axis

Tilt axis

Pan axis

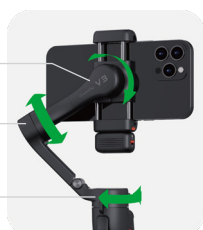

Press once to switch Working Modes.

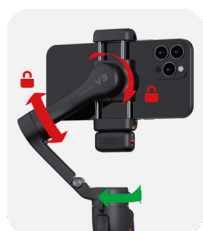

### Pan Follow Mode(PF)

**Axes Engaged:** Pan axis is active; Roll and Tilt axes are locked.

**Functionality:** The gimbal allows the phone to pan left or right smoothly following the operator's movements, while maintaining a steady tilt and roll position.



### Pan and Tilt Follow Mode(PTF)

**Axes Engaged:** Both Pan and Tilt axes are active; Roll axis is locked.

**Functionality:** This mode enables the phone to follow the operator's pan (left/right) and tilt (up/down) movements, offering more dynamic control over the framing. The roll axis remains locked to keep the horizon level.

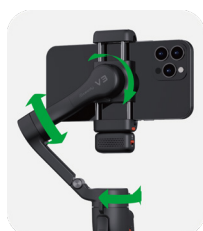

### Point of View Mode(POV)

**Axes Engaged:** All three axes (Roll, Tilt, and Pan) are active.

**Functionality:** This mode allows the phone to follow the operator's movements in all directions. It offers a "first-person" perspective, capturing footage as if the viewers are seeing through the operator's eyes.

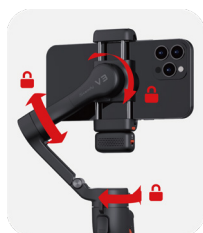

### All Lock Mode(L)

**Axes Engaged:** All three axes (Roll, Tilt, and Pan) are locked.

**Functionality:** In Lock Mode, the phone's orientation remains fixed regardless of the gimbal's movements.

## 09 Remote Control Operation

### \*Note:

- When attached to the gimbal, the remote control automatically powers on and pairs once the gimbal is on. The gimbal also charges the remote during this time.
- If detached from the gimbal, power on the remote control separately. It will automatically pair with the gimbal upon powering on.



### ① Joystick

Push vertically and horizontally to change the tilt and pan axis directions.

**Press twice:** Switch between zoom and roll control

**Long press:** Turn the fill light on/off.



### ② Adjustment Button

Zoom/Roll rotation/Fill light control

**Long press:** Control zoom\*/roll rotation

**Press once:** Control fill light brightness

**Press twice:** Switch fill light temperature

\*Zoom control is available exclusively through the Hohem Joy App after connecting via Bluetooth.



### ③ Function Button

**Press twice:** Recenter the gimbal

**Press three times:** Change the phone between forward-facing and backward-facing

**Press five times:** Re-pair the remote control

**Press seven times:** Clear Bluetooth connections

**Long press:** Enter All Lock Mode(L) (release button to exit)



### ④ Mode Button

**Press once:** Switch working Modes

**Press twice:** Switch between landscape and portrait mode

**Press three times:** Auto 180° roll rotation

**Press five times:** Enter auto calibration



### ⑤ Shutter Button

**Press once:** Take a photo or start/stop recording<sup>[1]</sup>

**Press twice:** Switch between photo/video mode<sup>[2]</sup>

**Press three times:** Switch between front/rear cameras<sup>[2]</sup>

**Long press:** Remote control power on/off<sup>[3]</sup>



### \*Notes:

1. This feature requires the gimbal to be connected to the smartphone via Bluetooth.
2. It is available exclusively through the Hohem Joy App after connecting via Bluetooth.
3. When the remote control is attached to the gimbal, it can simultaneously power the gimbal on/off.

# 10 Indicators

## Gimbal Handle



### ① Bluetooth Indicator

- **Solid light:** Bluetooth connected
- **Quick flash \*3:** Bluetooth pairing cleared (remote control power on/off)
- **Slow flash:** Gimbal firmware updating
- **Off:** Bluetooth disconnected



### ② Gimbal Battery Indicator

- **Solid light:** Battery level 50%-100%
  - **Solid light:** Battery level 20%-50%
  - **Solid light:** Low battery
  - **Quick flash:** Shutting down soon
- \*Battery indicator light flashing slowly indicates charging (different colors correspond to the current battery level)



### ③ Remote Connection Indicator

- **Solid light:** Remoter connected
- **Quick flash \*3:** Gimbal power on/off
- **Slow flash alternately:** Remote control re-pairing
- **Off:** Remote control disconnected
- **Slow flash:** Gimbal overloading
- **Solid light:** Gimbal firmware anomaly
- **Pulse:** Gimbal standby

## Remote Control



### ① Adjustment Indicator

**Solid light:** Roll rotation control

**Flash:** Fill light control

**Off:** Zoom in/out



### ② Bluetooth Indicator

**Solid light:** Bluetooth connected

**Quick flash \*3:** Bluetooth pairing cleared (remote control power on/off)

**Slow flash:** Gimbal firmware updating

**Off:** Bluetooth disconnected



### ③ Working Mode Indicator

PF

PTF

POV

L

**Slow flash:** Auto Calibration

**Pulse:** Gimbal standby



### ④ Gimbal Battery Indicator

**Solid light:** Battery level 50%-100%

**Solid light:** Battery level 20%-50%

**Solid light:** Gimbal Low battery

**Quick flash:** Gimbal Shutting down soon

\*Battery indicator light flashing slowly indicates charging (different colors correspond to the current battery level)



### ⑤ Remote Connection Indicator

**Solid light:** Remoter connected

**Slow flash:** Remote pairing/charging

**Quick Flash \*3:** Remote power on/off/ Paired

**Slow flash alternately:** Remote control re-pairing

**Off:** Remote control disconnected

**Solid light:** Remote low battery level

**Slow flash:** Remote shutting down soon

# 11 Hohem Joy App

## Downloading

Scan the QR code or search "Hohem Joy" in App Store / Google Play to download the App.









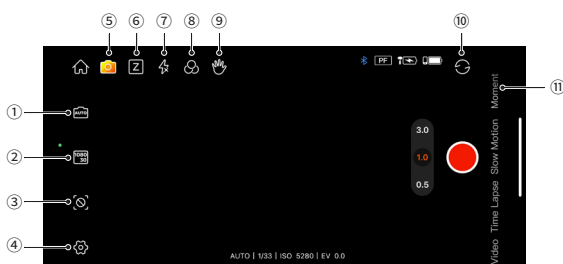







## Gimbal Connection

- ① Assembly your smartphone and turn on iSteady V3.
- ② Turn on Bluetooth on your smartphone.
- ③ Open the Hohem Joy App. Follow the on-screen instructions to complete the connection.

## Camera View



- |   |  |  |
|---|--|--|
| ① |  <b>Shooting Parameters</b>       | Displays the shutter speed, ISO, and EV values.  |
| ② |  <b>Resolution and Frame Rate</b> | Set resolution and video frame rate.   |
| ③ |  <b>AI Tracking</b>               | Choose between AI face tracking and AI object tracking.  |
| ④ |  <b>General Settings</b>          | Includes gimbal parameters*, camera parameters, and gimbal information.<br><br>*You can configure the gimbal to default to either landscape or portrait mode upon startup.   |
| ⑤ |  <b>Creative Studio</b>           | Provides shooting tutorials and ideas according to the situation or environment.   |
| ⑥ |  <b>Zoom/Focus</b>                | Adjust Zoom Control and Focus Control.   |
| ⑦ |  <b>Flash</b>                     | Adjust the flash.  |
| ⑧ |  <b>Filter</b>                    | Select a photo or a video filter.  |
| ⑨ |  <b>Gesture Control</b>           | Display Gesture Control settings and select from shoot, follow, or shoot with follow.<br><br>In photo mode, perform  to trigger a countdown for taking a photo.<br><br>In video mode, a  starts a countdown to begin recording, and  stops the recording. |
| ⑩ |  <b>Front/Rear</b>                | Tap to switch between the front and rear cameras of your smartphone.   |
| ⑪ |  <b>Moment Templates</b>          | Various video templates are available; simply tap to start, and the camera will automatically execute the moves to create a video.   |



For more information, visit [www.hohem.com](http://www.hohem.com), or scan the QR code to view tutorials.

# 12 Auto Calibration & Firmware Update

## Auto Calibration

Auto calibration could reduce drift or slight deviation caused by nearby magnetic interference or human error.



① Place the gimbal on a hard, flat surface after setting it up and powering it on.



② Press the trigger button twice to recenter the gimbal.



③ Press the M button five times to enter auto calibration.



④ A single "beep" indicates that the calibration is complete.

### \*Note:

- During the auto calibration process, ensure that the remote control is connected to the gimbal.
- Failing to place the gimbal on a flat surface for calibration will result in calibration failure (e.g., attempting calibration while holding it in a vehicle) .
- If calibration fails, you'll hear two beeps and see the Working Mode indicators pulsing, indicating standby mode. Double-tap the power button to exit standby and retry calibration.

## Firmware Update

You will be prompted in the Hohem Joy App if a new firmware update is available. Follow the on-screen instructions in the App to update firmware.



# 13 Specifications

## iSteady V3

<b>Weight</b>	420g(±5g)
<b>Dimensions</b>	Unfolded: 127*65*312mm Folded: 98*44*160.5mm
<b>Material</b>	High-performance composite material
<b>Maximum Load</b>	300g
<b>Mobile Phone Width</b>	58mm~98mm
<b>Battery Capacity</b>	7.4V/1400mAh
<b>Operating Time</b>	Approx. 13 hours (Used without AI Tracker unit) Approx. 4 hours (AI tracking and fill light is used simultaneously)
	*Data sourced from Hohem Laboratory. Measured under ideal conditions with the gimbal fully balanced.
<b>Charging Time</b>	Approx. 2.5 hours (5V-2A)
<b>Power Consumption</b>	0.8W (Approximate, measured under ideal conditions)
<b>Controllable Angle</b>	Pan: -120° to 210°   Roll: -195° to 135° Tilt: -35° to 45°
<b>Operating Temperature</b>	-10°C to 45° C (14 °F to 113 °F )
<b>Motor Protection</b>	The gimbal will automatically shut down in case of improper operation to protect the motor.

## AI Tracker

<b>Weight</b>	13.6g
<b>Dimensions</b>	42*16.5*25mm
<b>Lens Resolution</b>	1 mp
<b>Gesture Recognition Distance</b>	0.5 to 1.5m(1.64 to 4.92ft)
<b>Tracking Distance</b>	0.5 to 5m(1.64 to 16.4ft)
<b>Light Power</b>	2W
<b>Illuminance</b>	110lux@0.5M
<b>Color Temperature</b>	6500K (Cool light) 5000K (Neutral light) 2700K (Warm light)

## 14 Warning & Disclaimer

Thank you for purchasing the Hohem product. By using this product, you hereby signify that you have read this disclaimer and warning carefully. In addition, you understand and agree to abide by the terms and conditions herein. You acknowledge that you are solely responsible for your own conduct while interacting with this product, and for any consequences thereof. You agree to use this product only for purposes that are proper and in accordance with all applicable laws, rules, and regulations, and all terms, precautions, practices, policies and guidelines Hohem has made and may make available. Hohem accepts no liability for damage, injury, or any legal responsibility incurred directly or indirectly from the use of this product. The user shall observe safe and lawful practices including, but not limited to, those set forth in this document.

This document and all other collateral documents are subject to change at the sole discretion of Hohem. For up-to-date product information, visit [www.hohem.com](http://www.hohem.com) and click on the product page for this product.

**hohem**

**Email:** [service@hohem.com](mailto:service@hohem.com)

**Website:** [www.hohem.com](http://www.hohem.com)

**Manufacturer:** Shenzhen Hohem Technology Co.,Ltd



**Connect us at  
Facebook**

# 15 Warranty Terms

- ① Customers are entitled to replacement service in case of quality deficits or functional disorders found in the product within fifteen (15) calendar days of receiving a product.
- ② The valid warranty period is 12 months counting from the date of selling under normal use. Accessories are excluded from the warranty service. The warranty service is subject to normal use. Damage exceeding this period, or damage caused by force majeure, is not covered by warranty. This includes damages not related to the product's quality such as collisions, burns, unauthorized repairs or modifications, foreign objects (water, oil, sand, etc.), and damages resulting from improper installation or use. Our company can offer paid repair services for such issues.
- ③ Please keep and offer the warranty card for claiming the warranty service.

## CALL CENTER -Toll Free

---

### UNITED STATES:

+1(888)9658512

Mon-Fri: 9:00AM-5:00PM(EST)

---

### UNITED KINGDOM:

+44(0)808 2737578

Mon-Fri: 2:00PM-10:00PM(GMT +0)

---

### CANADA:

+1(855)758 8939

Mon-Fri: 9:00AM-5:00PM(EST)

---

### BRAZIL:

+55 (0)800 5911897

Mon-Fri: 10:00AM-6:00PM(GMT -3)

---

hohem

[www.hohem.com](http://www.hohem.com)

